

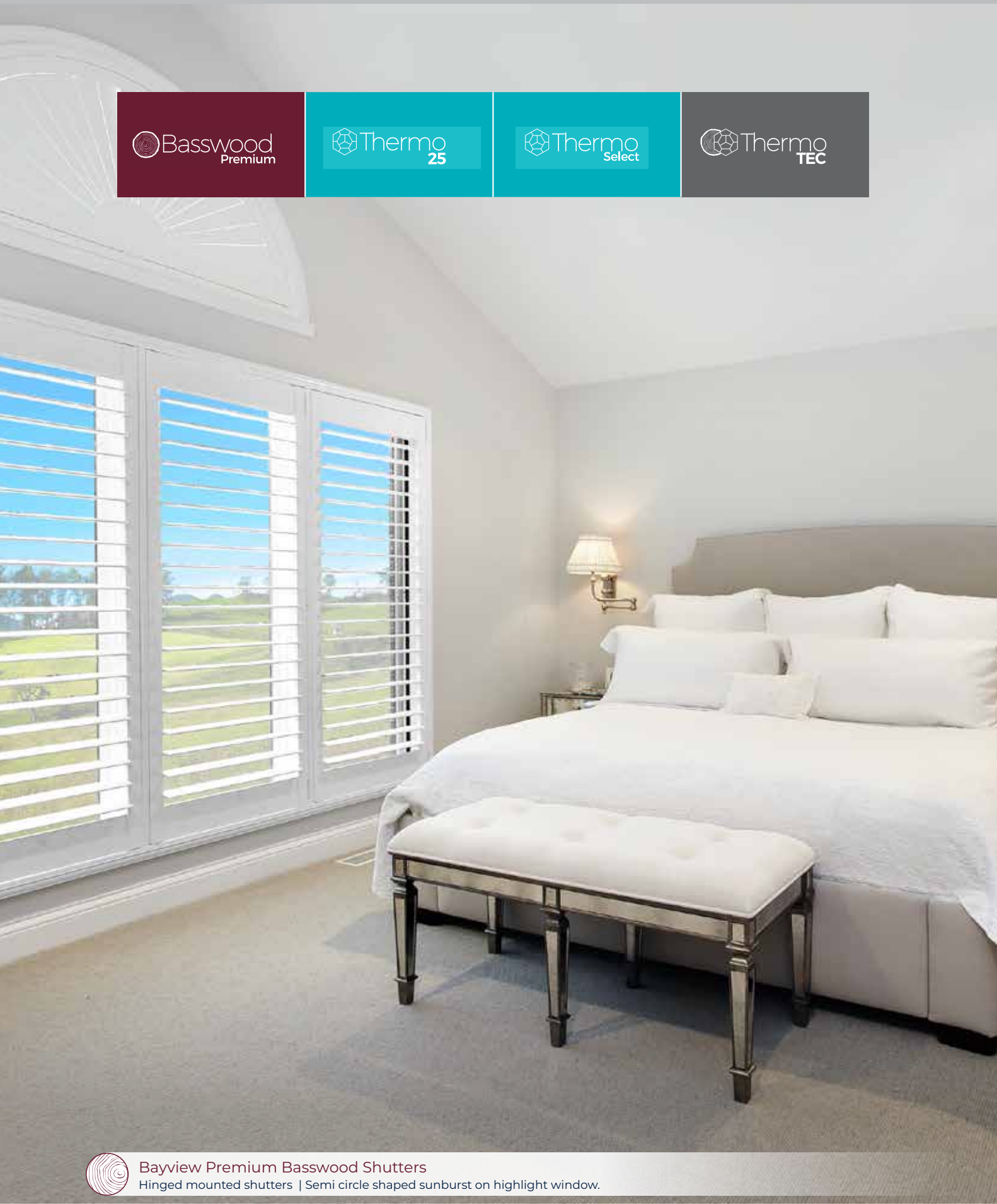

CRAFTSMANSHIP, CUSTOMISATION & CLASS



PLANTATION SHUTTERS

best decision for your home



 Bayview Premium Basswood Shutters
Hinged mounted shutters | Semi circle shaped sunburst on highlight window.



the best decision for your home

Bayview plantation shutters are synonymous with quality craftsmanship, comprehensive bespoke options and luxury with longevity. Bayview is a popular classic and premium window covering solution which remains an opulent and valuable product. Through quality craftsmanship and customisation of decorative and shaped framing options, these plantation shutters enhance the atmosphere in any room for every home.



Our Bayview Brand Promise is to deliver shutters of the highest quality which are manufactured to perfectly fit any window making this comprehensive range the best decision for your home.



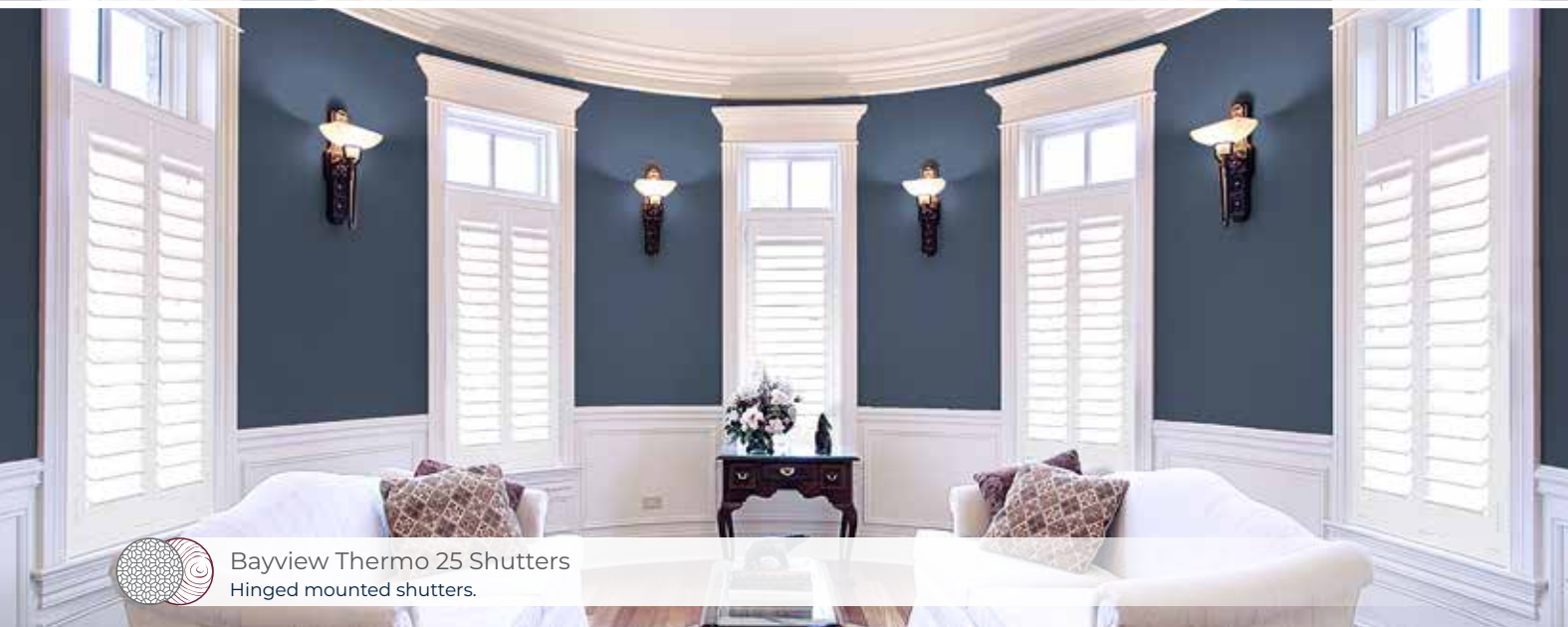

 Bayview Thermo 25 Shutters
Hinged mounted shutters.



 Bayview Premium Basswood Shutters
Hinged mounted shutters | painted an accent colour with mid rail construction.



 Bayview Thermo 25 Shutters
Hinged mounted shutters.

comprehensive & convenient

Complete control of light and mood

Each panel can be adjusted to filter and control light. Bayview shutters will let natural light in and still maintain privacy.

No fuss and low maintenance

Bayview shutters are made with quality craftsmanship to ensure longevity and minimal user maintenance. Unlike other window solutions, Bayview are virtually fuss free too! These shutters are very quick and easy to clean and are excellent for dust allergy sufferers.

Insulated and economical

Bayview will keep you cool during summer and help retain the heat during the winter making them a perfect solution to reduce your bills.

Comprehensive customisation

Bayview shutters are manufactured to suit all window shapes and sizes because this premium product is custom made to suit any window.

This versatile range ensures that you get the most value and life out of your product in wet, dry or high usage areas.

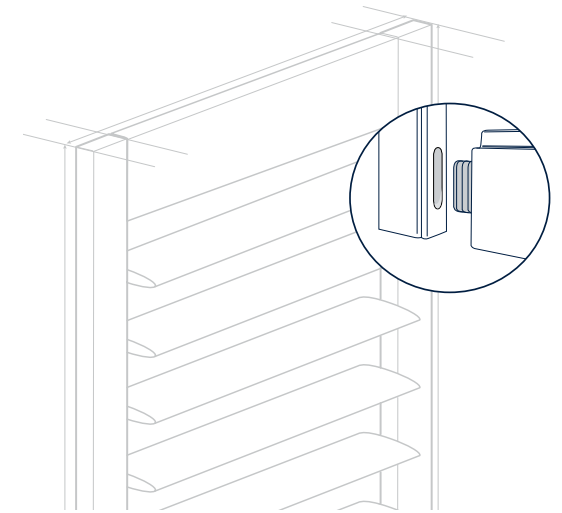

Mortise and tenon joints, glued and screwed for stronger wider panels.



 Bayview Premium Basswood Shutters
Hinged mounted shutters | stained

Shutter Type

Timber

Basswood Premium

- **Stile and Blades** constructed from Premium Basswood timber creating stiff light weight panels.
- **Valspar 2 Pac paint or stain**, painted after assembly.



Thermopoly™

Thermo 25

- **Stile and Blades** constructed from Thermopoly. This is a hard wearing and moisture resistant polyresin.
- **Valspar 2 Pac paint**, painted after assembly.



Hybrid Timber & Thermopoly™

Thermo TEC

- **Stiles** constructed from Premium Basswood timber creating stiff light weight panels.
- **Blades** engineered from Thermopoly for longevity that won't crack, chip or warp.
- **Valspar 2 Pac paint**, painted after assembly.

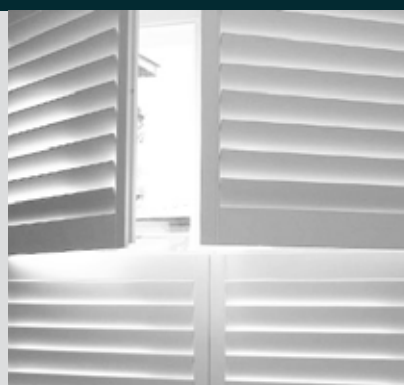

Thermopoly™

Thermo Select

- **Stile and Blades** constructed from Thermopoly. This is a hard wearing and moisture resistant polyresin.
- **Water based paint**, pre-painted provides economical option.



Comparison Table

Basswood Premium	Thermo Select+25	Thermo TEC
High grade European Basswood frames and blades High grade European timber sourced only from FSC certified forests.	Polyresin blades with aluminium core with polyresin frames. Recyclable material and fire retardant.	High grade European Basswood frames with polyresin blades with aluminium core. High grade European timber sourced only from FSC certified forests.
Low Maintenance	Low Maintenance	Low Maintenance
Hypo Allergenic and Pet Friendly	Hypo Allergenic and Pet Friendly	Hypo Allergenic and Pet Friendly
Comprehensive colour, shapes and framing options.	Moisture Resistance	Comprehensive shapes available.
Energy Efficient	Energy Efficient	Energy Efficient

WARRANTY				
PAINTED 5yr paint, 5yr construction*	STAINED 3yr paint, 5 yr construction*	THERMO 25 10yr paint, 25yr construction*	SELECT 5yr paint, 20yr construction*	PAINTED 5yr paint 5yr construction*

COLOUR OPTIONS			
PAINTED			
BASSWOOD PREMIUM 20 colours Valspar 2 pac poly	THERMO 25 15 colours Valspar 2 pac poly	SELECT 4 colours Water Based	THERMO TEC 18 colours Valspar 2 pac poly
STAINED			
BASSWOOD PREMIUM 11 stain colours & painted black hand stained then clear lacquered	THERMO 25 not available	SELECT not available	THERMO TEC not available
CUSTOM COLOURS			
BASSWOOD PREMIUM Available	THERMO 25 Light colours only	SELECT Not Available	THERMO TEC Light colours only
Full range of painted and stained colour to highlight natural timber qualities. (Black and other dark colours available.)			

Selection Guide

MOUNTING OPTIONS

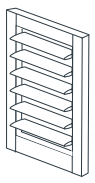

Standard Hinged

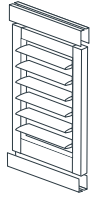

Fixed

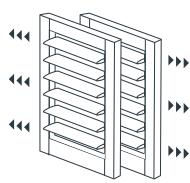

Sliding

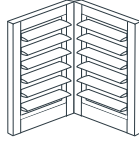

Corner Windows

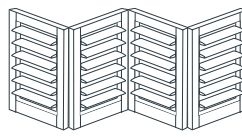

Bi Folds

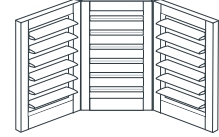

Bay Window

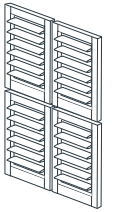

Tier on Tier

BLADE SIZE

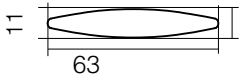

63

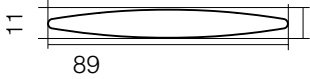

89



114

TILT TYPE

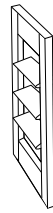

Clearview

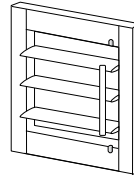

Offset tilt

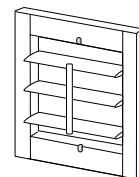

Centre tilt

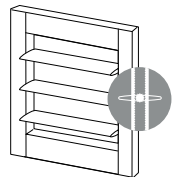

Internal tilt

CUSTOM & SPECIALIST SHAPES

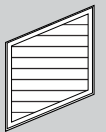
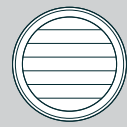
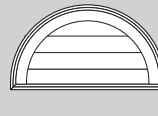
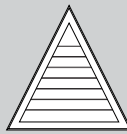
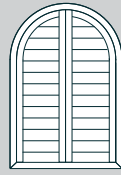

best decision for your home



Copyright ©
CW Systems